

DESCRIPTION AND RATING

The 6CX8 is a miniature tube containing a sharp-cutoff pentode and a medium-mu triode in one envelope. The pentode section is intended primarily for use as a video amplifier. The triode section is suitable for a sweep oscillator, sync separator, sync amplifier, or sync clipper.

Except for heater ratings, the 8CX8 is identical to the 6CX8. In addition, it incorporates a controlled heater warm-up characteristic which makes it especially suited for use in television receivers with series-connected heaters.

GENERAL

ELECTRICAL

Cathode—Coated Unipotential			
Heater Voltage, AC or DC	6.3 ± 10%	8.0	Volts
Heater Current	0.75	0.6 ± 6%	Amperes
Heater Warm-up Time*		11	Seconds
Direct Interelectrode Capacitances†			

Pentode Section

Grid-Number 1 to Plate	0.06	μμf
Input	9.0	μμf
Output	4.4	μμf

Triode Section

Grid to Plate	4.4	μμf
Input	2.2	μμf
Output	0.38	μμf

Pentode Grid-Number 1 to Triode Plate, maximum	.005	μμf
Triode Grid to Pentode Plate, maximum	.018	μμf
Pentode Plate to Triode Plate, maximum	.017	μμf

MECHANICAL

Mounting Position—Any
Envelope—T-6½, Glass
Base—E9-1 Small Button 9-Pin

MAXIMUM RATINGS

DESIGN-MAXIMUM VALUES, See Note on page 2

	Pentode Section	Triode Section
Plate Voltage	330	330 Volts
Screen-Supply Voltage	330	... Volts
Screen Voltage—See Screen Rating Chart		
Positive DC Grid-Number 1 Voltage	0	0 Volts
Plate Dissipation	5.0	2.0 Watts
Screen Dissipation	1.1	... Watts
Heater-Cathode Voltage		
Heater Positive with Respect to Cathode		
DC Component	100	100 Volts
Total DC and Peak	200	200 Volts
Heater Negative with Respect to Cathode		
Total DC and Peak	200	200 Volts
Grid-Number 1 Circuit Resistance		
With Fixed Bias	0.25	0.5 Megohms
With Cathode Bias	1.0	1.0 Megohms

BASING DIAGRAM

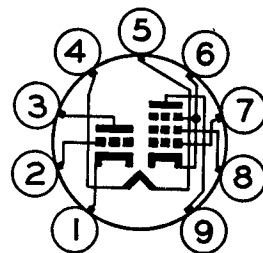

EIA 9DX

TERMINAL CONNECTIONS

- Pin 1—Triode Cathode
- Pin 2—Triode Grid
- Pin 3—Triode Plate
- Pin 4—Heater
- Pin 5—Heater
- Pin 6—Pentode Cathode, Grid Number 3, and Internal Shield
- Pin 7—Pentode Grid Number 1
- Pin 8—Pentode Grid Number 2 (Screen)
- Pin 9—Pentode Plate

PHYSICAL DIMENSIONS

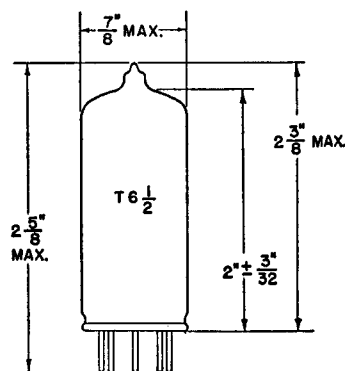

EIA 6-3

The tubes and arrangements disclosed herein may be covered by patents of General Electric Company or others. Neither the disclosure of any information herein nor the sale of tubes by General Electric Company conveys any license under patent claims covering combinations of tubes with other devices or elements. In the absence of an express written agreement to the contrary, General Electric Company assumes no liability for patent infringement arising out of any use of the tubes with other devices or elements by any purchaser of tubes or others.

Design-Maximum ratings are limiting values of operating and environmental conditions applicable to a bogey tube of a specified type as defined by its published data, and should not be exceeded under the worst probable conditions.

The tube manufacturer chooses these values to provide acceptable serviceability of the tube, taking responsibility for the effects of changes in operating conditions due to variations in tube characteristics.

The equipment manufacturer should design so that initially and throughout life no design-maximum value for the intended service is exceeded with a bogey tube under the worst probable operating conditions with respect to supply-voltage variation, equipment component variation, equipment control adjustment, load variation, signal variation, and environmental conditions.

CHARACTERISTICS AND TYPICAL OPERATION

CLASS A₁ AMPLIFIER

	Pentode Section	Triode Section
Plate Voltage	200	150 Volts
Screen Voltage	125 Volts
Grid-Number 1 Voltage	0‡ Volts
Cathode-Bias Resistor	68	150 Ohms
Amplification Factor	40
Plate Resistance, approximate	70000	8700 Ohms
Transconductance	10000	4600 Micromhos
Plate Current40	9.2 Milliampers
Screen Current	15.5 Milliampers
Grid-Number 1 Voltage, approximate I _b = 100 Microamperes	-8.5	-5.0 Volts

* The time required for the voltage across the heater to reach 80 percent of its rated value after applying 4 times rated heater voltage to a circuit consisting of the tube heater in series with a resistance equal to 3 times the rated heater voltage divided by the rated heater current.

† Without external shield.

‡ Applied for short interval (two seconds maximum) so as not to damage tube.

SCREEN RATING CHART

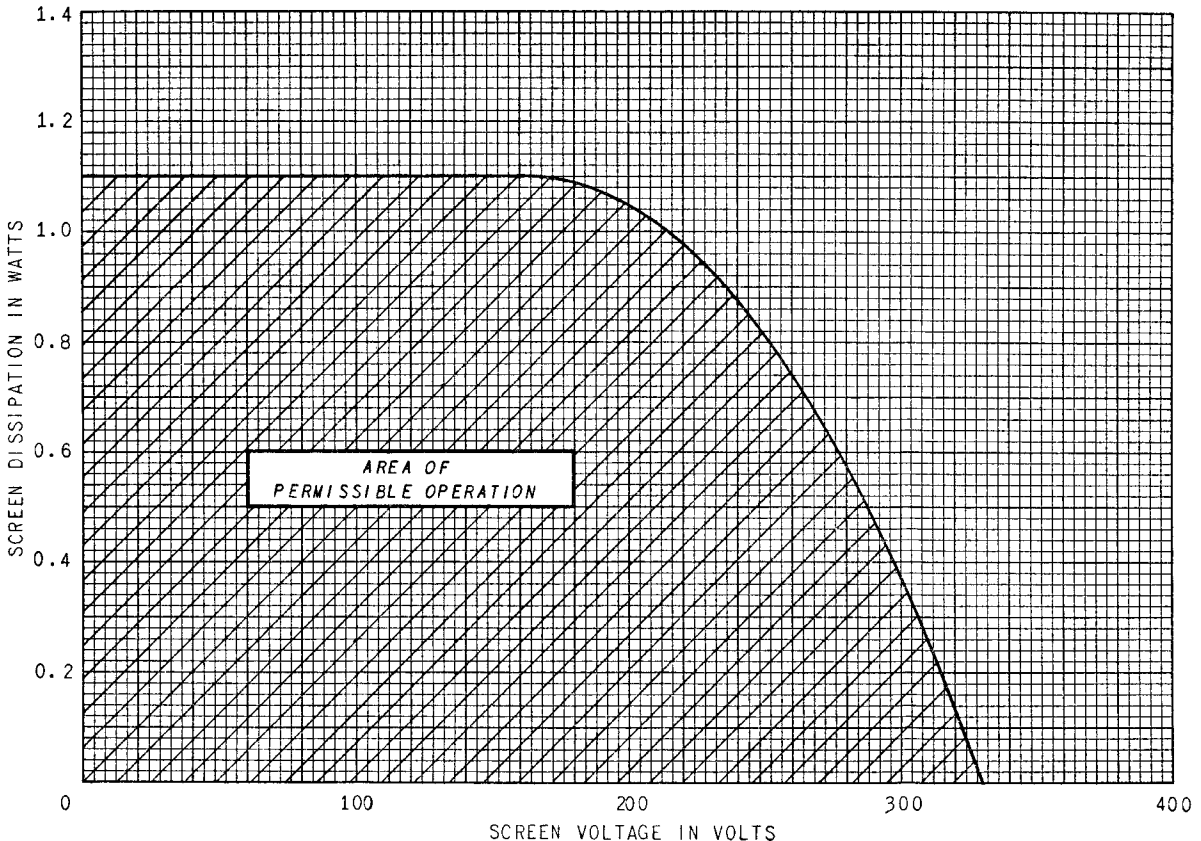

AVERAGE PLATE CHARACTERISTICS

TRIODE SECTION

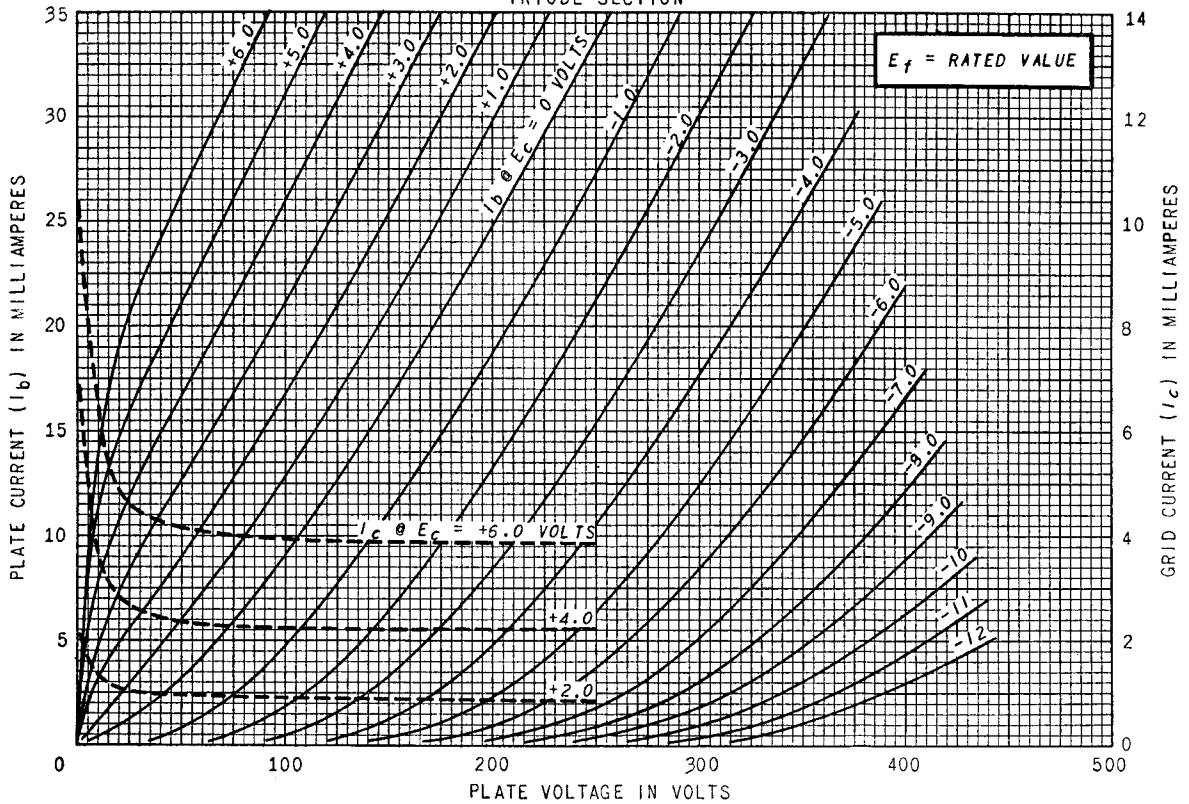

AVERAGE TRANSFER CHARACTERISTICS

TRIODE SECTION

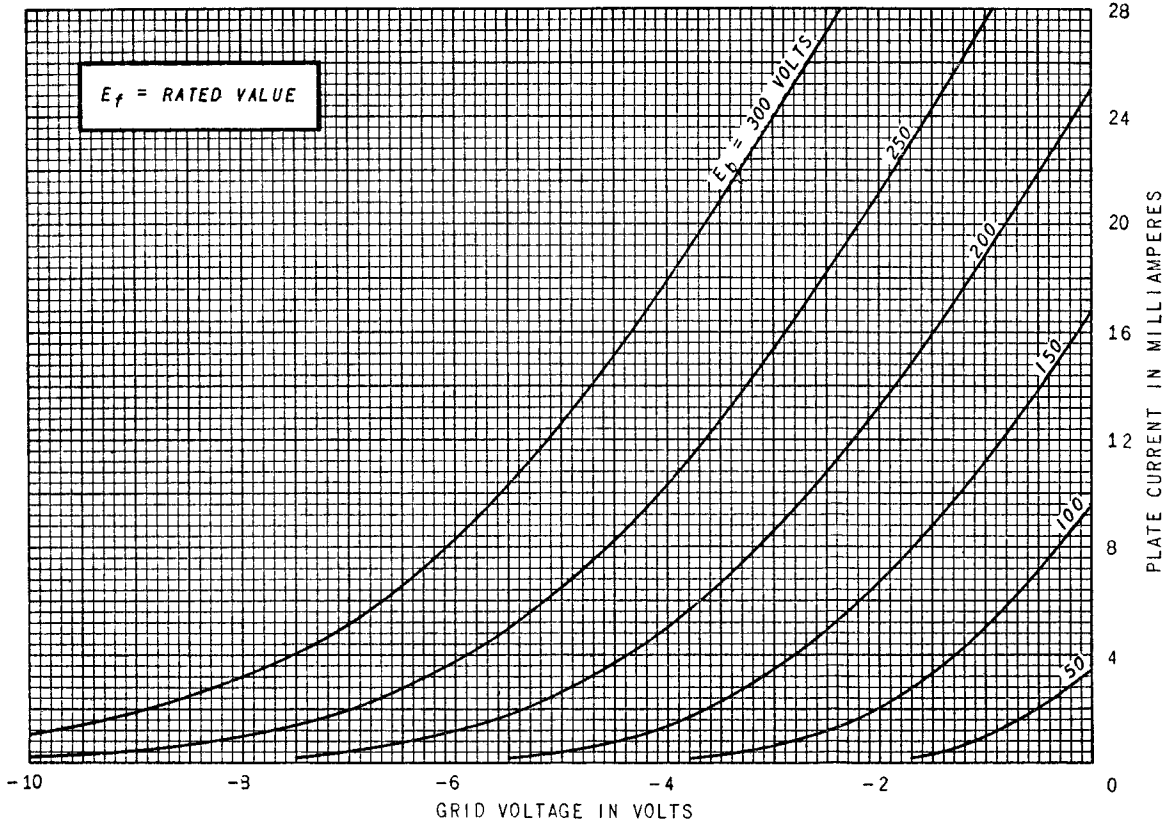

Δ Supersedes page 3 dated 1-59.

AVERAGE CHARACTERISTICS

TRIODE SECTION

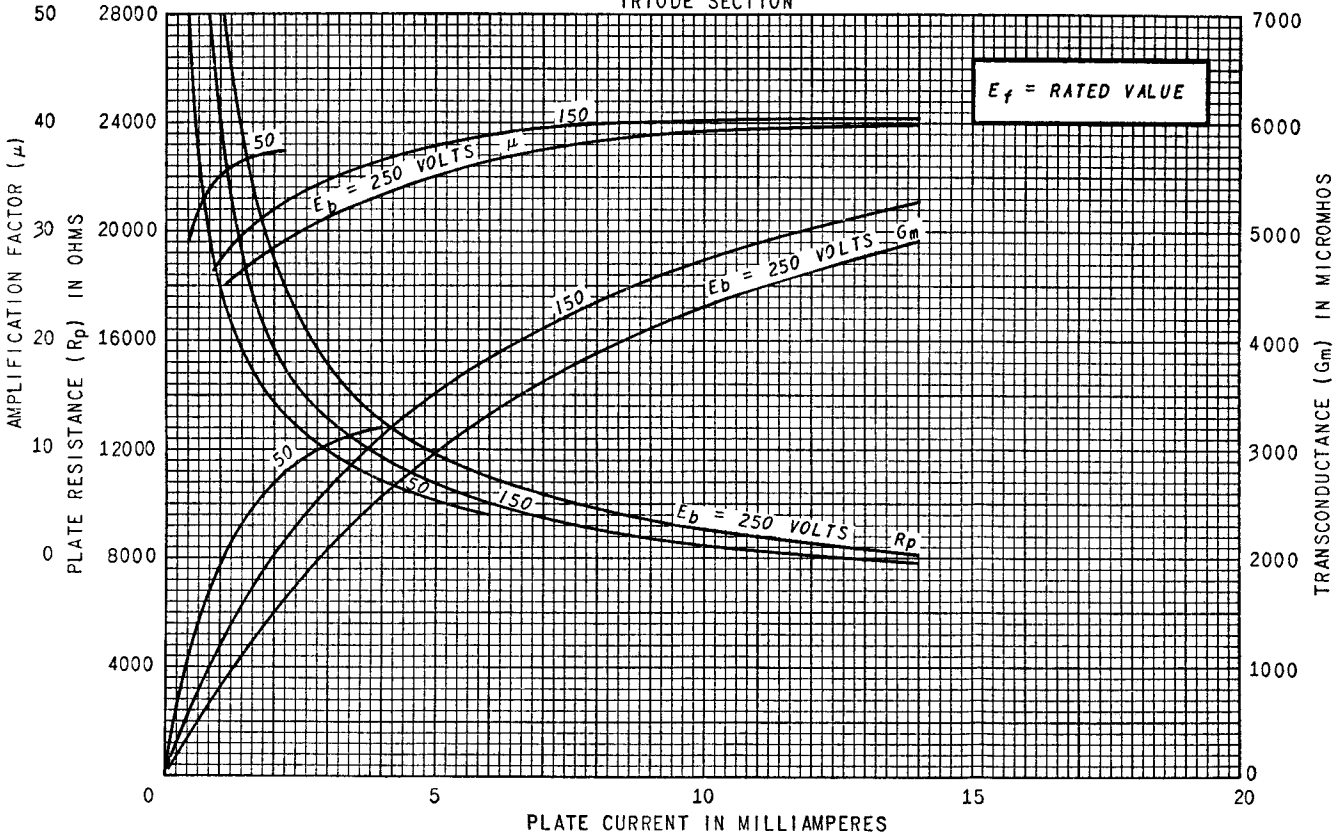

AVERAGE PLATE CHARACTERISTICS

PENTODE SECTION

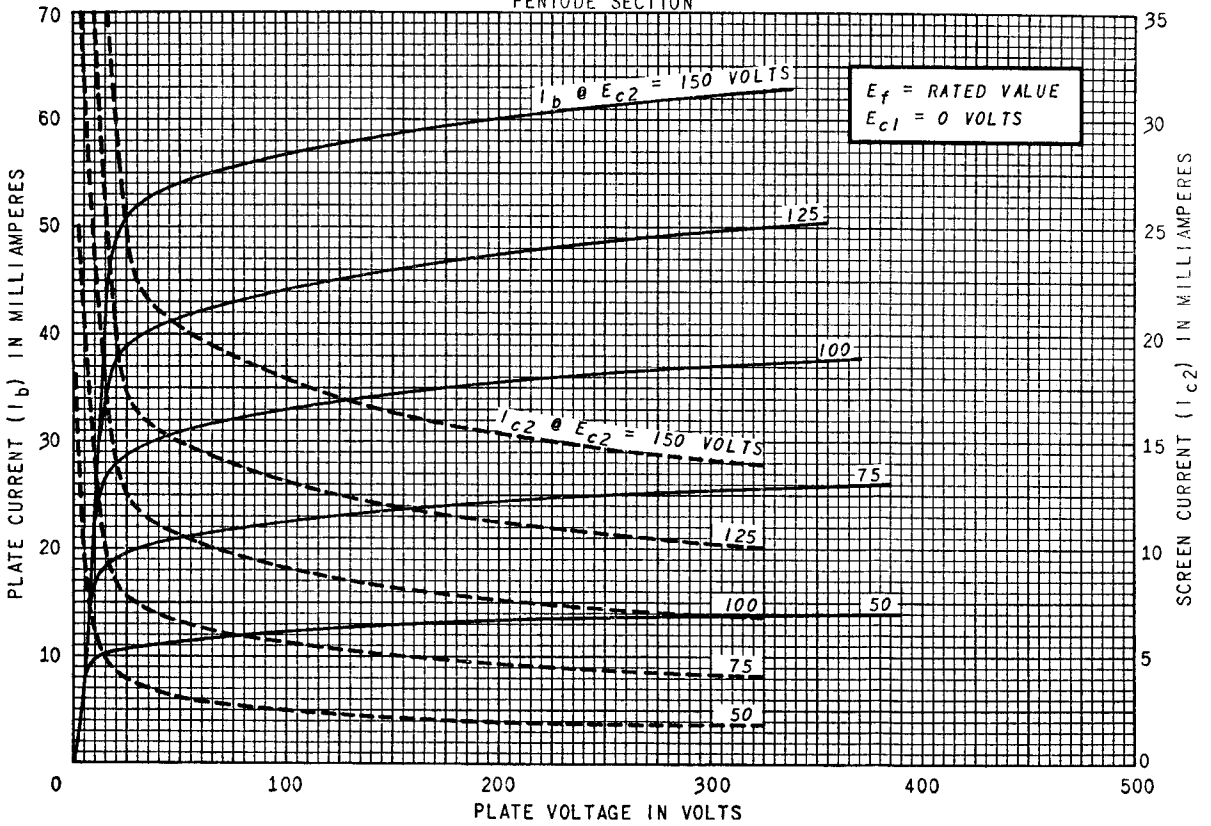

AVERAGE PLATE CHARACTERISTICS

PENTODE SECTION

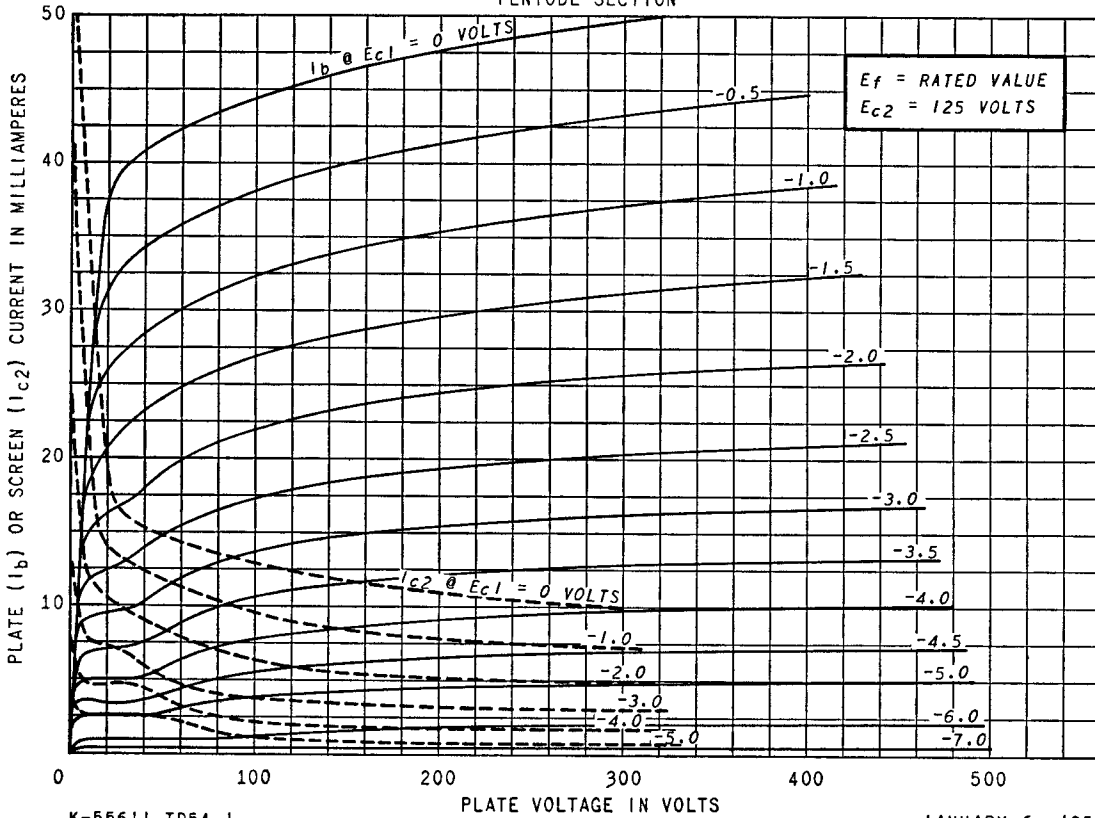

K-55611-TD54-1

JANUARY 6, 1959

AVERAGE TRANSFER CHARACTERISTICS

PENTODE SECTION

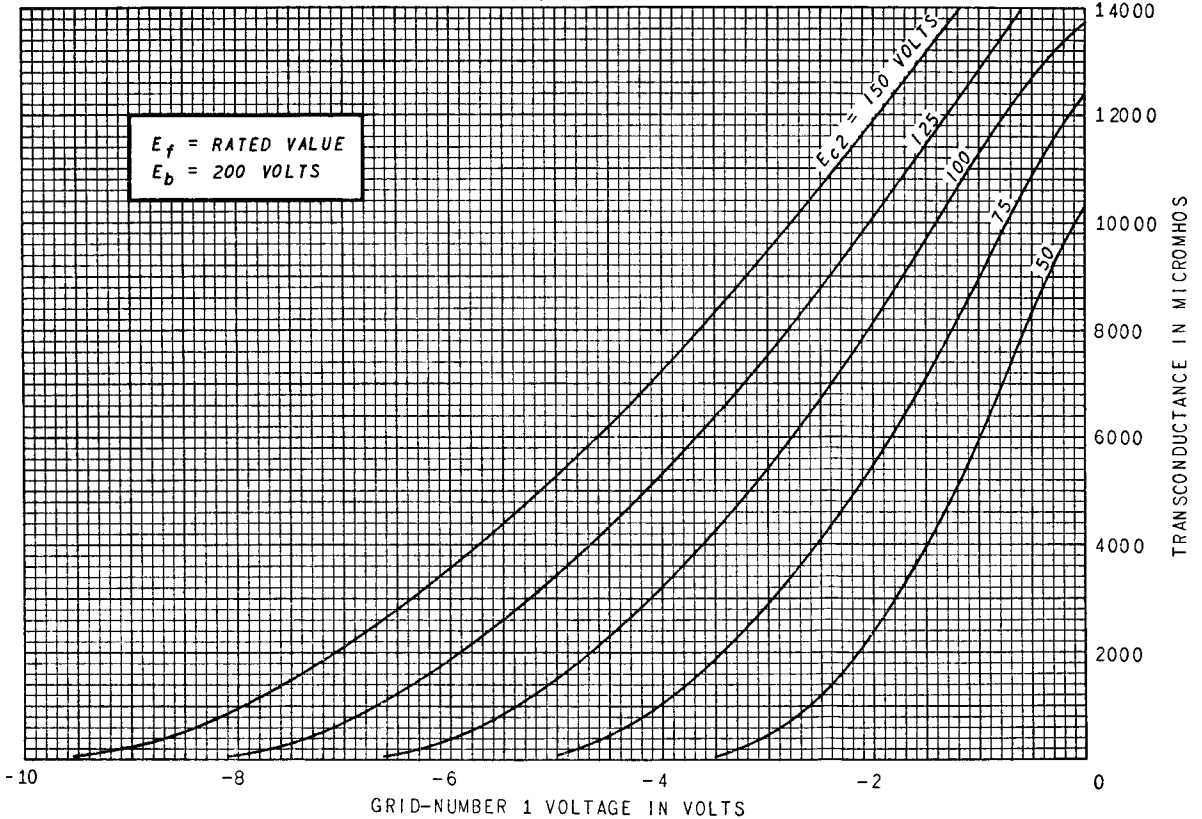

AVERAGE TRANSFER CHARACTERISTICS

PENTODE SECTION

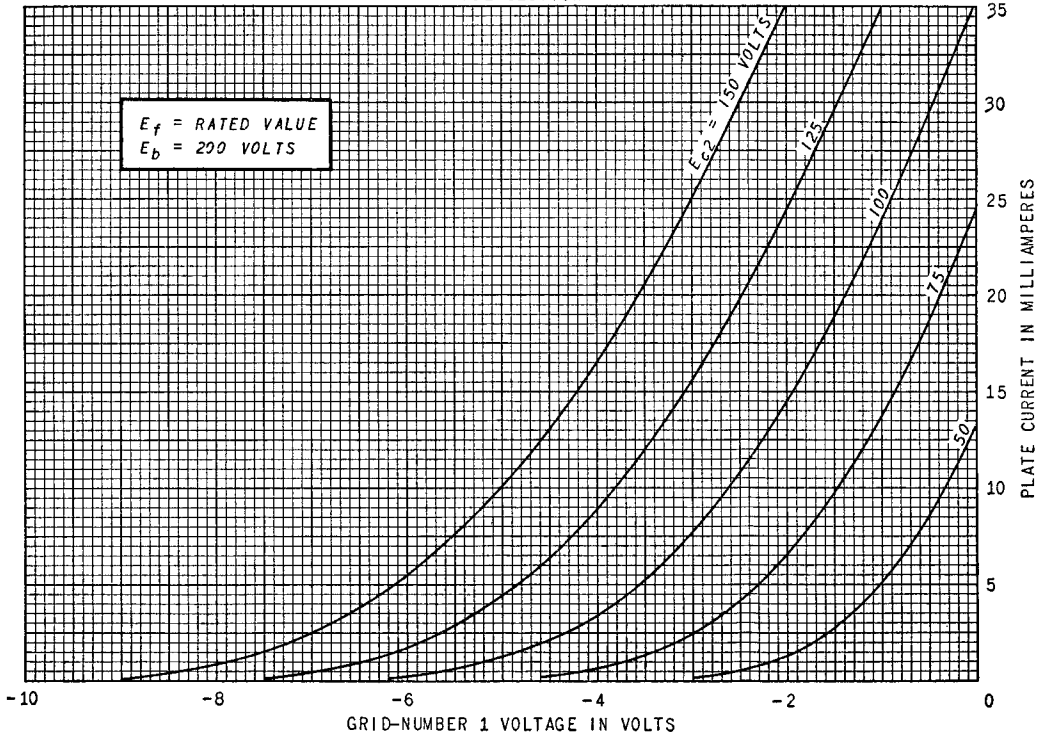

AVERAGE TRANSFER CHARACTERISTICS

PENTODE SECTION

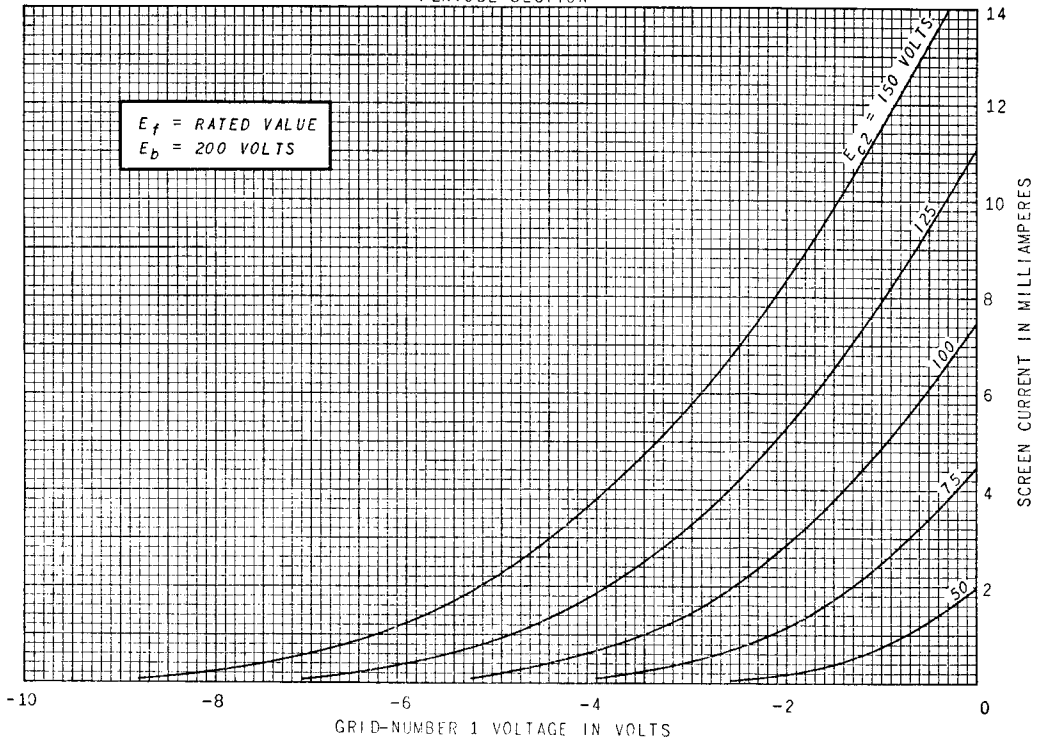

ELECTRONIC COMPONENTS DIVISION



Schenectady 5, N. Y.